

LEDX PHOENIX AQUA 1
9000 Kelvin

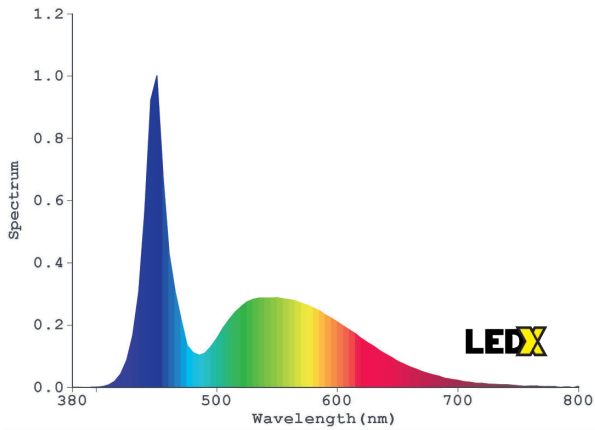

LEDX PHOENIX AQUA 2
11000 Kelvin

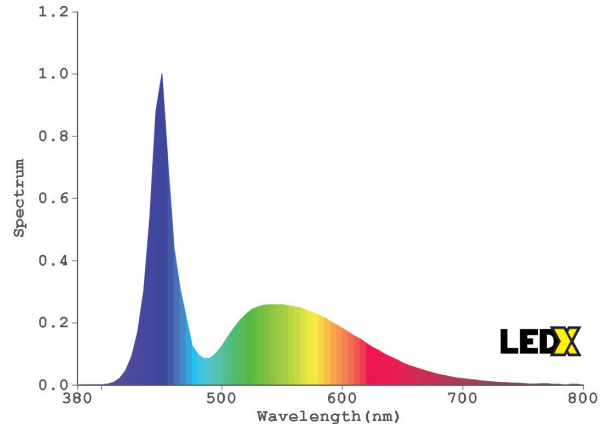

LEDX PHOENIX AQUA 3
14000 Kelvin

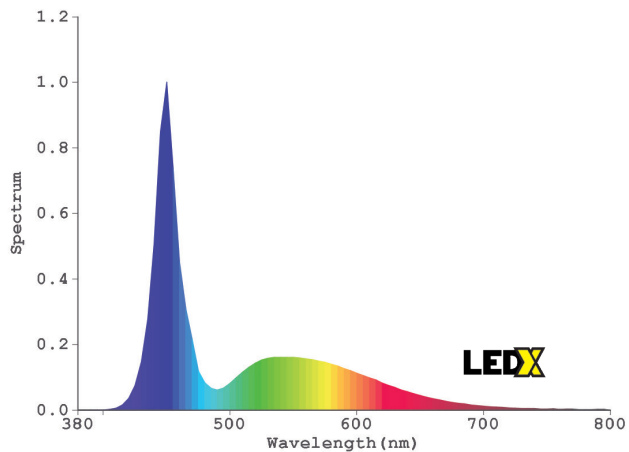

LEDX PHOENIX AQUA 4
15000 Kelvin

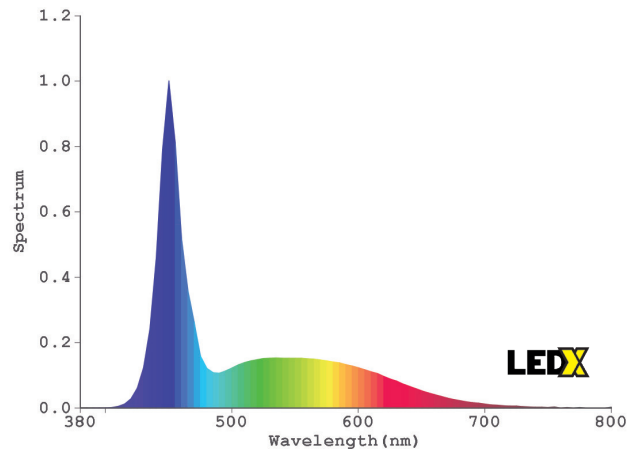

LEDX PHOENIX AQUA 5
18000 Kelvin

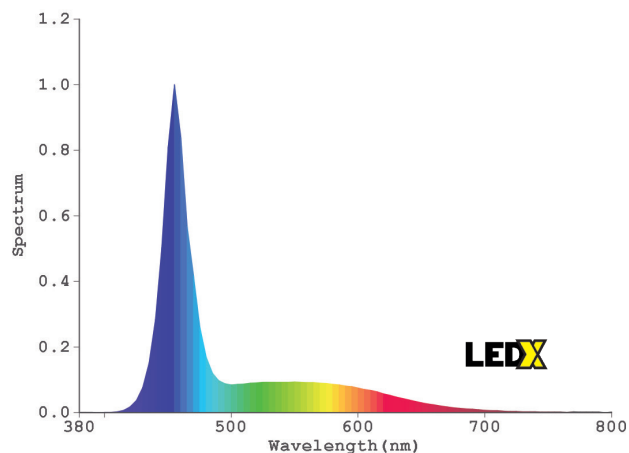

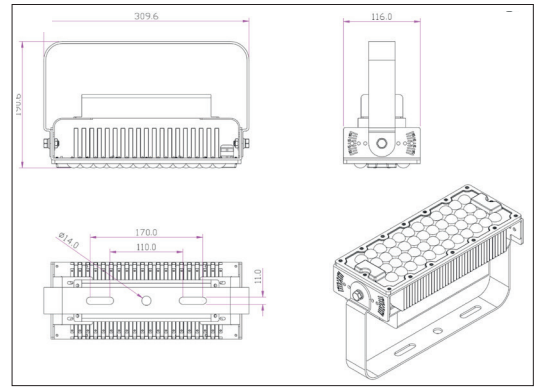

DATA SHEET

LEDX PHOENIX AQUA
120 watts
including power adapter
and power adapter box



Item number	LEDX-PHOENIX AQUA-120W
LED Type	SMD
LED Power supply	Meanwell or equivalent
LED Power	120 watt
Voltage	AC90-305V
Frequency	50/60 Hz
Light color	9000/11000/14000/15000 or 18000 Kelvin
Beam angle	20° / 40° / 60° / 90° or H140xV100
Ambient temperature	-40° to +55° C
Luminous flux	18000 Lumens at 11000 Kelvin
Colour reproduction	CRI 74 depending on the color of the light
Power Factor	≥ 0,95
Switching resistance	> 100000
Start-up time	1 second
Ingress Protection	IP65
Protection class	I
Impact resistance	IK 08
Weight	3 kg
Dimensions	L310 x W116 x H132mm
Material	Aluminum, PMMA, Stainless Steel
Dimming	not dimmable dimmable optional: 0-10V, DALI or Zigbee
Others	incl. 2 meter connection with EU plug (EU plug IP20, only for test) Housing color gray/silver
Energy efficiency	C
Lifespan	L70/B20 at 50000 hours
Certificates	CE, RoHS

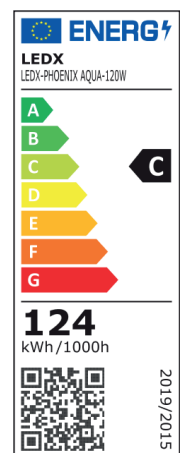

Our general terms and conditions apply. See also www.ledx.at.
 A deviation of the technical data of +/-10% is possible. Misprints and errors excepted.
 Product pictures are exemplary and may deviate from the original.
 We reserve the right to make formal and technical changes.

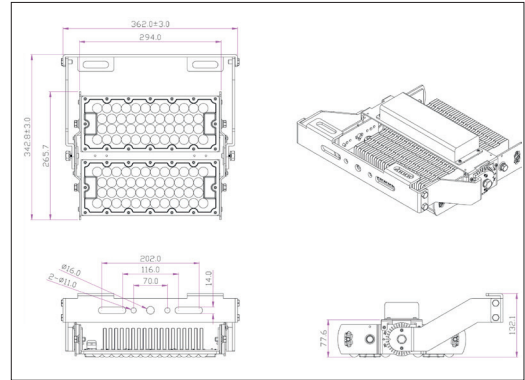
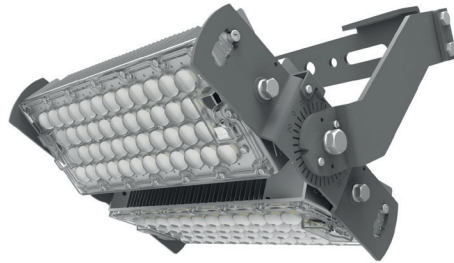

DATA SHEET

LEDX PHOENIX AQUA
240 watts
including power adapter
and power adapter box



Item number	LEDX-PHOENIX AQUA-240W
LED Type	SMD
LED Power supply	Meanwell or equivalent
LED Power	240 watt
Voltage	AC90-305V
Frequency	50/60 Hz
Light color	9000/11000/14000/15000 or 18000 Kelvin
Beam angle	20° / 40° / 60° / 90° or H140xV100
Ambient temperature	-40° to +55° C
Luminous flux	36000 Lumens at 11000 Kelvin
Colour reproduction	CRI 74 depending on the color of the light
Power Factor	≥ 0,95
Switching resistance	> 100000
Start-up time	1 second
Ingress Protection	IP65
Protection class	I
Impact resistance	IK 08
Weight	5 kg
Dimensions	L358 x W343 x H132mm
Material	Aluminum, PMMA, Stainless Steel
Dimming	not dimmable dimmable optional: 0-10V, DALI or Zigbee
Others	incl. 2 meter connection with EU plug (EU plug IP20, only for test) Housing color gray/silver
Energy efficiency	C
Lifespan	L70/B20 at 50000 hours
Certificates	CE, RoHS

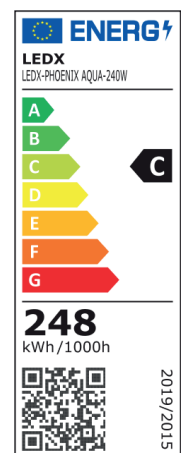

Our general terms and conditions apply. See also www.ledx.at.
 A deviation of the technical data of +/-10% is possible. Misprints and errors excepted.
 Product pictures are exemplary and may deviate from the original.
 We reserve the right to make formal and technical changes.

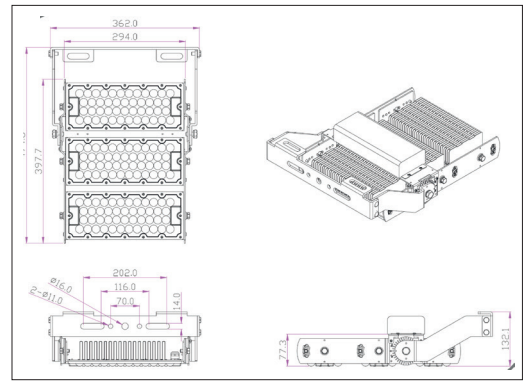

DATA SHEET

LEDX PHOENIX AQUA
360 watts
including power adapter
and power adapter box

Item number	LEDX-PHOENIX AQUA-360W
LED Type	SMD
LED Power supply	Meanwell or equivalent
LED Power	360 watt
Voltage	AC90-305V
Frequency	50/60 Hz
Light color	9000/11000/14000/15000 or 18000 Kelvin
Beam angle	20° / 40° / 60° / 90° or H140xV100
Ambient temperature	-40° to +55° C
Luminous flux	54000 Lumens at 11000 Kelvin
Colour reproduction	CRI 74 depending on the color of the light
Power Factor	≥ 0,95
Switching resistance	> 100000
Start-up time	1 second
Ingress Protection	IP65
Protection class	I
Impact resistance	IK 08
Weight	7 kg
Dimensions	L358 x W476 x H132mm
Material	Aluminum, PMMA, Stainless Steel
Dimming	not dimmable dimmable optional: 0-10V, DALI or Zigbee
Others	incl. 2 meter connection with EU plug (EU plug IP20, only for test) Housing color gray/silver
Energy efficiency	C
Lifespan	L70/B20 at 50000 hours
Certificates	CE, RoHS

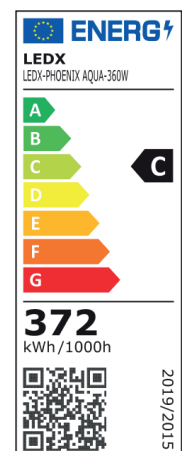

Our general terms and conditions apply. See also www.ledx.at.
 A deviation of the technical data of +/-10% is possible. Misprints and errors excepted.
 Product pictures are exemplary and may deviate from the original.
 We reserve the right to make formal and technical changes.

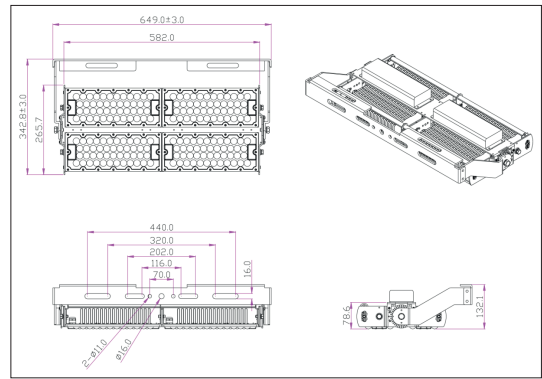

DATA SHEET

LEDX PHOENIX AQUA
480 watts
including power adapter
and power adapter box

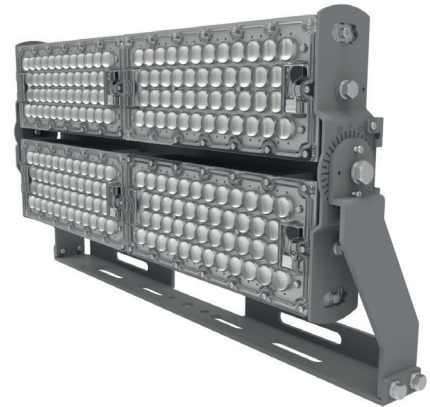

Item number	LEDX-PHOENIX AQUA-480W
LED Type	SMD
LED Power supply	Meanwell or equivalent
LED Power	480 watt
Voltage	AC90-305V
Frequency	50/60 Hz
Light color	9000/11000/14000/15000 or 18000 Kelvin
Beam angle	20° / 40° / 60° / 90° or H140xV100
Ambient temperature	-40° to +55° C
Luminous flux	72000 Lumens at 11000 Kelvin
Colour reproduction	CRI 74 depending on the color of the light
Power Factor	≥ 0,95
Switching resistance	> 100000
Start-up time	1 second
Ingress Protection	IP65
Protection class	I
Impact resistance	IK 08
Weight	9 kg
Dimensions	L650 x W343 x H132mm
Material	Aluminum, PMMA, Stainless Steel
Dimming	not dimmable dimmable optional: 0-10V, DALI or Zigbee
Others	incl. 2 meter connection with EU plug (EU plug IP20, only for test) Housing color gray/silver
Energy efficiency	C
Lifespan	L70/B20 at 50000 hours
Certificates	CE, RoHS

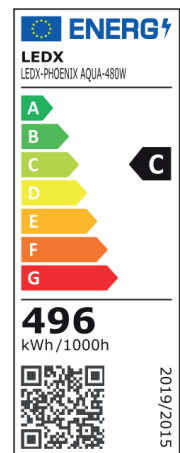

Our general terms and conditions apply. See also www.ledx.at.
 A deviation of the technical data of +/-10% is possible. Misprints and errors excepted.
 Product pictures are exemplary and may deviate from the original.
 We reserve the right to make formal and technical changes.